

TO THE READER

This Workshop Manual has been prepared to provide servicing personnel with information on the mechanism, service and maintenance of KUBOTA Tractors L2900, L3300, L3600 and L4200. It is divided into two parts, "Mechanism" and "Servicing" for each section.

■ Mechanism

Information on the construction and function are included. This part should be understood before proceeding with troubleshooting, disassembling and servicing.

■ Servicing

Under the heading "General" section comes general precautions, check and maintenance and special tools. Other section, there are troubleshooting, servicing specification lists, checking and adjusting, disassembling and assembling, and servicing which cover procedures, precautions, factory specifications and allowable limits.

All information, illustrations and specifications contained in this manual are based on the latest production information available at the time of publication.

The right is reserved to make changes in all information at any time without notice.

September '94

© KUBOTA Corporation 1994

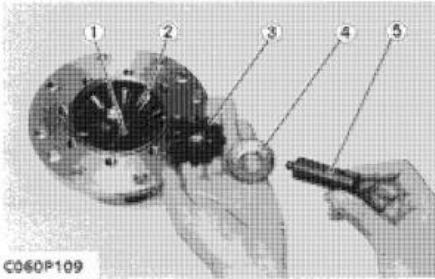

C060P109

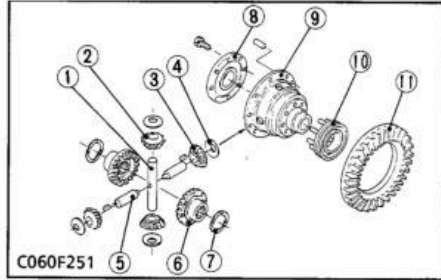

C060F251



C045P214

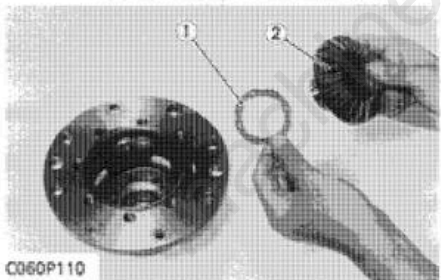

C060P110

SERVICING

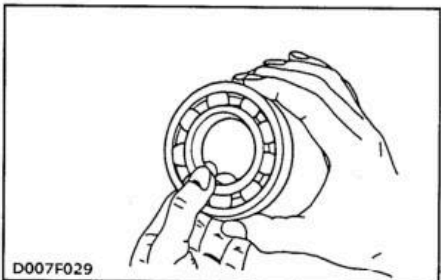

D007F029

Differential Pinion Shaft and Differential Pinion

1. Draw out the differential pinion shaft 2 (5), and take out the differential pinion (3) and differential pinion washer (4).
2. Draw out the differential pinion shaft (1), and take out the differential pinion (2) and differential pinion washer.

NOTE

- Arrange the parts to know their original position.

(When reassembling)

- Check the differential pinions (2), (3) and pinion shaft (1), (5) for excessive wear. If these parts are damaged or excessively worn, replace their parts they are in mesh with, or they sliding on.
- Apply molybdenum disulfide (Three Bond 1901 or equivalent) to the inner circumferential surface of the differential pinions.
- Install the parts to their original position.
- Install the differential pinion washer (4), noting its groove position.

[A] Fit Groove

- | | |
|---------------------------------|-----------------------------------|
| (1) Differential Pinion Shaft | (7) Differential Side Gear Washer |
| (2) Differential Pinion | (8) Differential Case Cover |
| (3) Differential Pinion | (9) Differential Case |
| (4) Differential Pinion Washer | (10) Differential Lock Shifter |
| (5) Differential Pinion Shaft 2 | (11) Spiral Bevel Gear |
| (6) Differential Side Gear | |

Differential Side Gear

1. Take out the differential side gear (2) and differential side gear washer (1).

(When reassembling)

- Check the thrust and bearing surface of both differential side gears (2). If they are worn or damaged, bores in the differential case may also be damaged. Be sure to replace their parts.

- | | |
|-----------------------------------|----------------------------|
| (1) Differential Side Gear Washer | (2) Differential Side Gear |
|-----------------------------------|----------------------------|

Checking Bearing

1. Hold the inner race, and push and pull the outer race in all directions to check for wear and roughness.
2. Apply transmission fluid to the bearing, and hold the inner race. Then, turn the outer race to check rotation.
3. If there is any defect, replace it.

HYDRAULIC CYLINDER

Item		Factory Specification	Allowable Limit
Cylinder Bore	I.D.	90.000 to 90.050 mm 3.54330 to 3.54527 in.	90.150 mm 3.54921 in.
Hydraulic Arm Shaft to Bushing	Clearance (Right)	0.125 to 0.230 mm 0.00492 to 0.00906 in.	0.50 mm 0.0197 in.
	(Left)	0.125 to 0.220 mm 0.00492 to 0.00866 in.	0.50 mm 0.0197 in.
Hydraulic Arm shaft	O.D. (Right)	44.920 to 44.950 mm 1.76850 to 1.76968 in.	-
	(Left)	39.920 to 39.950 mm 1.57165 to 1.57283 in.	-
Bushing	I.D. (Right)	45.075 to 45.150 mm 1.77460 to 1.77756 in.	-
	(Left)	40.075 to 40.140 mm 1.57775 to 1.58031 in.	-

TIGHTENING TORQUES

Tightening torques of screws and nuts on the table below are especially specified.
(For general use screws and nuts : See page G-9)

Item	N·m	kgf·m	ft-lbs
Delivery pipe joint bolt (Three point system hydraulic pump to front hydraulic block)	49.0 to 58.8	5.0 to 6.0	36.2 to 43.4
GST - independent PTO delivery pipe joint bolt	34.3 to 39.2	3.5 to 4.0	25.3 to 28.9
Power steering delivery hose joint bolt	49.0 to 58.8	5.0 to 6.0	36.2 to 43.4
Delivery pipe joint bolt (Power steering hydraulic pump to regulator valve)	39.3 to 49.0	4.0 to 5.0	29.0 to 36.2
Regulator valve mounting screws	17.6 to 20.6	1.8 to 2.1	13.0 to 15.2
Hydraulic pump assembly mounting screw and nut	23.6 to 27.4	2.4 to 2.8	17.4 to 20.2
Rear wheel mounting stud bolt	98.1 to 112.7	10.0 to 11.5	72.3 to 83.1
Rear wheel mounting screws and nuts	197 to 226	20 to 23	145 to 166
Control linkage assembly mounting screws	23.6 to 27.4	2.4 to 2.8	17.4 to 20.2
Arm 2 lock nut	29.4 to 39.2	3.0 to 4.0	21.7 to 28.9
Relief valve plug	49.0 to 68.6	5.0 to 7.0	36.2 to 50.6
ROPS mounting screws			
M14 screws	124 to 147	12.6 to 15.0	91.2 to 108
M16 screws	196 to 225	20.0 to 23.0	145 to 166
GST shift cable mounting screws	7.8 to 8.8	0.8 to 0.9	5.8 to 6.5
Floor seat mounting bolts and nuts	197 to 226	20 to 23	145 to 166
Hydraulic cylinder assembly mounting stud bolts	34.3 to 49.0	3.5 to 5.0	25.3 to 36.2
Hydraulic cylinder assembly mounting screws and nuts	77.4 to 90.2	7.9 to 9.2	57.1 to 66.5
Position control valve mounting screws	23.6 to 27.4	2.4 to 2.8	17.4 to 20.2

[7] GAUGES CHECKING

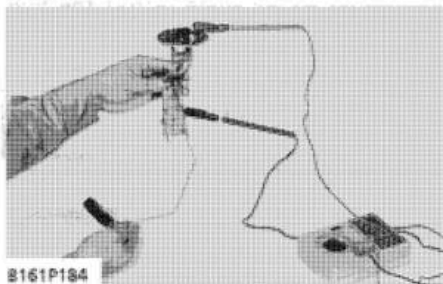

B161P184

Fuel Level Sensor Continuity

1. Remove the fuel level sensor from the fuel tank.
2. Measure the resistance with an ohmmeter across the sensor terminal and its body.
3. If the measurement are not indicated, the sensor is faulty.

Resistance Sensor terminal - its body	Factory spec.	Float at upper- most position	1 to 5 ohms
		Float at lower- most position	103 to 117 ohms

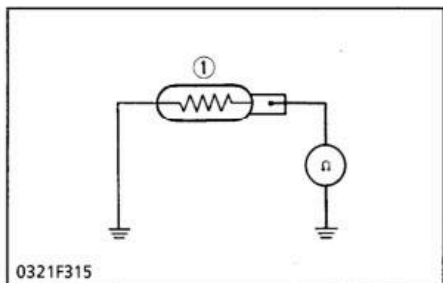

0321F315

Coolant Temperature Sensor Continuity

1. Measure the resistance with an ohmmeter across the sensor terminal and the chassis.
2. If the measurement is not indicated, the sensor is faulty.

Resistance Sensor terminal - Chassis	Reference value	Approx. 16 ohms at 120 °C (248 °F) Approx. 50 ohms at 80 °C (176 °F) Approx. 149 ohms at 50 °C (122 °F)
--	--------------------	---

- (1) Coolant Temperature Sensor

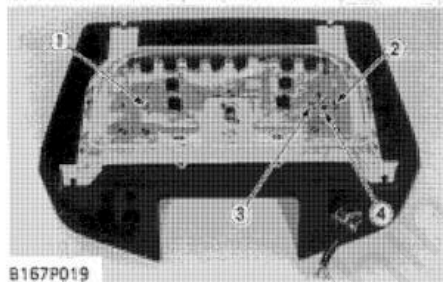

B167P019

Fuel Gauge and Coolant Temperature Gauge Continuity

1. Remove the panel board from the tractor.
2. Check the continuity with an ohmmeter across the FU terminal (2) and IG terminal (3) and across the FU terminal (2) and GND terminal (4).
3. If infinity is indicated, the fuel gauge is faulty.
4. Check the continuity with an ohmmeter across the TU terminal (1) and IG terminal (3) and across the TU terminal (1) and GND terminal (4).
5. If infinity is indicated, the coolant temperature gauge is faulty.

- (1) TU Terminal
(2) FU Terminal

- (3) IG Terminal
(4) GND Terminal

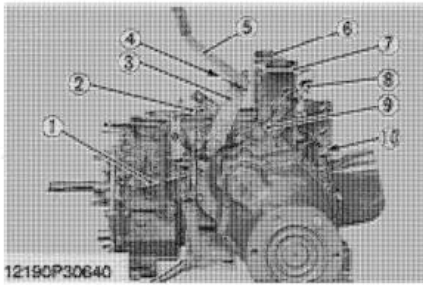

12190P30640

Fender Mount Stay and Range Gear Shift Levers

1. Remove the both rear wheels and support rear axles with stand.
2. Remove the wiring harness (4).
3. Remove the fender mount stay RH (6) and fender mount stay LH (7) with safety switch (8).
4. Remove the shift rod H-M (1) and shift rod L (2).
5. Remove the external snap ring and remove the range gear shift levers (3), (4), (5).
6. Remove the external snap ring and remove the neutral switch link (9) with neutral switch rod (11).

(When reassembling)

- Adjust clearance "A" between safety switch (8) and neutral switch rod (11), when range gear shift lever is M position.
- If the length of shift rod H-M (1) and shift rod L (2) are changed or replace with new ones, adjust the their length following below procedure.
 - i) Set lever H-M (12) and lever L (13) to neutral position.
 - ii) Assemble all the parts.
 - iii) Adjust for pin "B" (14) of range gear shift lever H-M (3) to become center of T shape hole (15) of lever L (13) with shift rod H-M (1). (See figure left.)
 - iv) Adjust shift rod L (2) length until the top of the range gear shift lever H-M (3) and lever L (4) get in alignment as shown figure.

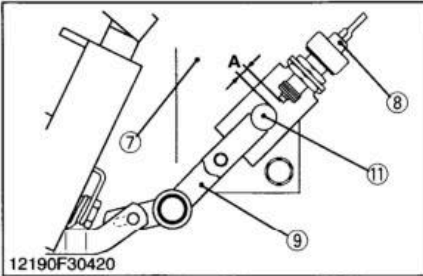

12190F30420

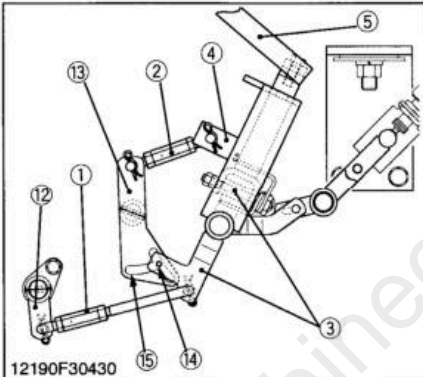

12190F30430

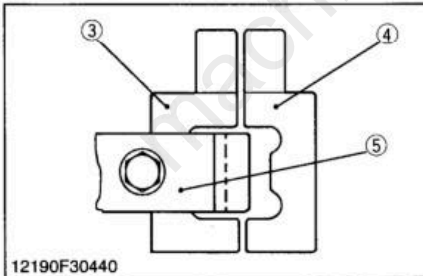

12190F30440

Tightening torque	Rear wheel mounting screws and nuts	197 to 226 N·m 20 to 23 kgf·m 145 to 166 ft·lbs
-------------------	-------------------------------------	---

- | | |
|---------------------------------|-------------------------|
| (1) Shift Rod H-M | (10) Wiring Harness |
| (2) Shift Rod L | (11) Neutral Switch Rod |
| (3) Range Gear Shift Lever H-M | (12) Lever H-M |
| (4) Range Gear Shift Lever L | (13) Lever L |
| (5) Range Gear Shift Main Lever | (14) Pin B |
| (6) Fender Mount Stay RH | (15) T Shape Hole |
| (7) Fender Mount Stay LH | |
| (8) Safety Switch | |
| (9) Neutral Switch Link | |

A : Clearance A : 4 to 5 mm (0.16 to 0.20 in.)

12190S30580

Full Version Available

Kubota L4200 Tractor Workshop Manual

This is a short preview. The complete manual contains all chapters, wiring diagrams, torque specifications and full service procedures.

VIEW THE FULL MANUAL

<https://machinecatalogic.com/kubota-l4200-tractor-workshop-manual/>