

WSM

WORKSHOP MANUAL
FRONT LOADER

**LA1301, LA1301S-1,
LA1601, LA1601S**

Kubota

MECHANISM

CONTENTS

1. FEATURES	M-1
2. HYDRAULIC CIRCUIT	M-2
3. CONTROL VALVE ASSEMBLY AND RELIEF VALVE	M-3
4. BOOM CYLINDER AND BUCKET CYLINDER.....	M-4
5. RELIEF VALVE	M-5
[1] MAIN RELIEF VALVE	M-5
[2] PORT RELIEF VALVE [SERIAL NUMBER ABOVE 10219]	M-7

machinecatalogic.com

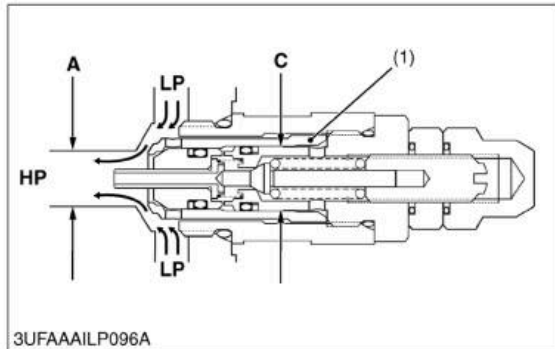

■ Anti-cavitation Operation

The anti-void unit supplies oil to the high pressure port **HP** when cavitation has occurred. A lower pressure exists in the port **HP** compared to the low pressure chamber **LP**. The difference between the effective area of diameter **A** and **C** causes imbalance of the check valve poppet (1) which unseats, thus allowing oil from the low pressure chamber **LP** to enter the port **HP** and fill the void.

(1) Check Valve Poppet

W1015539

[2] PORT RELIEF VALVE [SERIAL NUMBER ABOVE 10219]

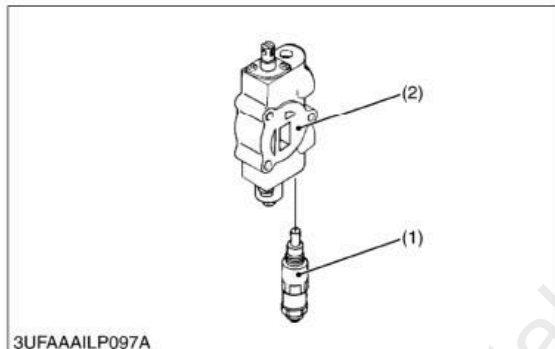

This valve is installed on the bucket control valve (2) as shown in figure.

If an external load is imposed on the bucket cylinder, pressure builds in the circuit. When the pressure exceeds the set level, the relief valve opens and the oil returns to tank.

This relief valve is a type of combination valve which is combining a relief operation and anti-cavitation operation.

This valve is composed as shown in the left figure, and relief operation and anti-cavitation operation of this valve function same as main relief valve.

(Reference)

- Valve setting pressure : 16.7 to 17.1 MPa
170 to 175 kgf/cm²
2415 to 2485 psi

Condition

- Oil temperature : 45 to 55 °C
113 to 131 °F

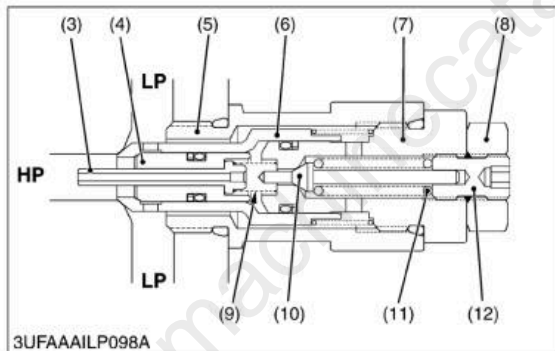

- | | |
|--------------------------|-------------------|
| (1) Port Relief Valve | (10) Pilot Poppet |
| (2) Bucket Control Valve | (11) Pilot Spring |
| (3) Piston Poppet | (12) Adjust Screw |
| (4) Relief Valve Poppet | |
| (5) Housing | |
| (6) Check Valve Poppet | |
| (7) Pilot Section | |
| (8) Lock Nut | |
| (9) Piston Spring | |
- LP : Low Pressure Chamber (Tank Port)**
HP : High Pressure Port (A2 Port)

W1015725

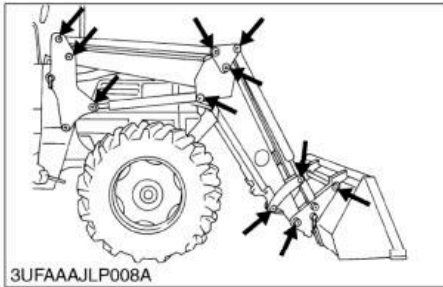
(2) Check Points of Every 10 Hours**Greasing**

1. Inject grease in all grease fitting with a hand grease gun.

W1011132

Lubricating

1. Lubricate joints of control lever linkage.

W1011274

machinecatalogic.com

(C) Disassembling Controller

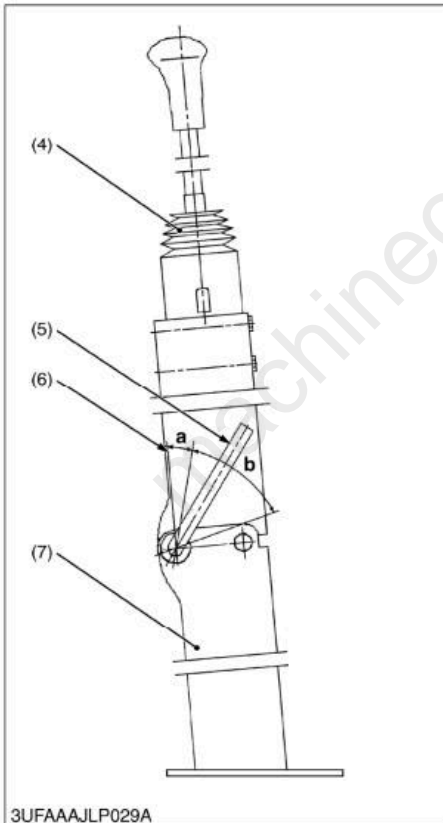
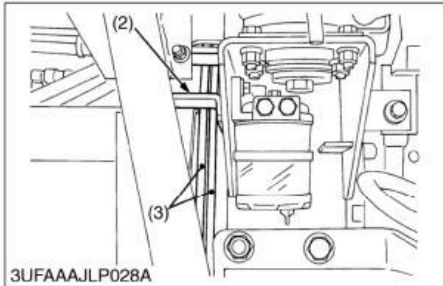
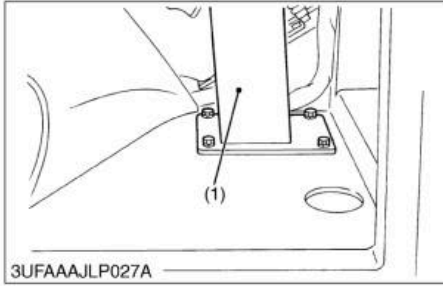

Controller Stand

1. Remove the controller stand assembly (1) with the cables (3) from the cabin floor.
2. Remove the controller (4) with the cables (3) from the controller stand 2 (6).
3. Remove the bolt, 3/8" lock nut, nut and lock lever (5).
4. Remove the controller stand 2 (6) from the controller stand 1 (7).

(When reassembling)

- When installing the controller stand 1 (7) and 2 (6), adjust the direction of 1/2" nut so that the lock lever (5) should be located with 1.05 rad (60 °). After hand tightening as shown in the figure.
- When installing the controller stand 1 (7) and 2 (6), the controller stand 2 (6) should be rotated by hand.
- Attach the controller stand assembly (1) to the cabin floor after routing the cables (3) through the holes on the cabin floor and cabin bracket (2).

Tightening torque	3/8" lock nut	15 to 20 N·m 1.5 to 2.1 kgf·m 11 to 15 ft·lbs
-------------------	---------------	---

- (1) Controller Stand Assembly
- (2) Cabin Bracket
- (3) Cable
- (4) Controller
- (5) Lock Lever
- (6) Controller Stand 2
- (7) Controller Stand 1

- a : 0.26 rad (15 °)
- b : 1.05 rad (60 °)

W1018188

Full Version Available

Kubota LA1301S-1 Front Loader Workshop Manual

This is a short preview. The complete manual contains all chapters, wiring diagrams, torque specifications and full service procedures.

VIEW THE FULL MANUAL

<https://machinecatalogic.com/kubota-la1301s-1-front-loader-workshop-manual/>