

WSM

WORKSHOP MANUAL
FRONT LOADER

LA513 • LA723 • LA853

Kubota

1. HYDRAULIC CIRCUIT

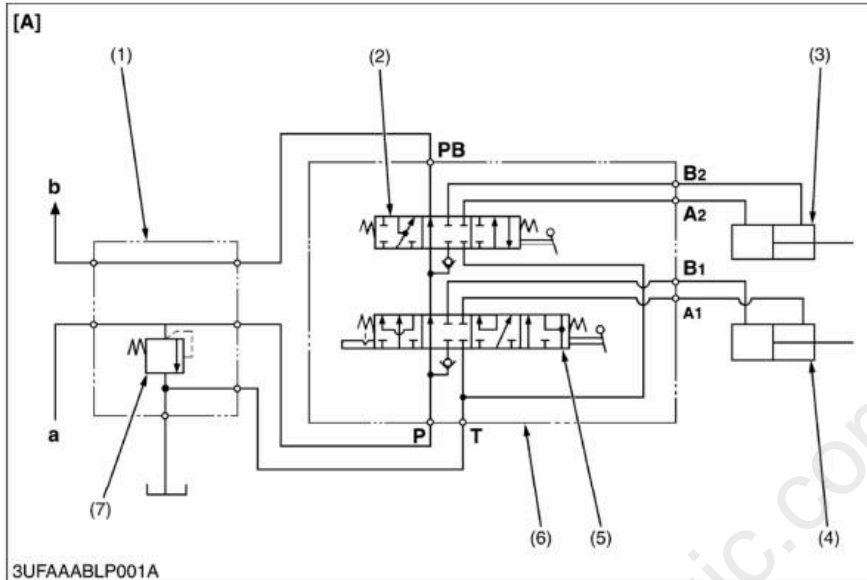

W1016476

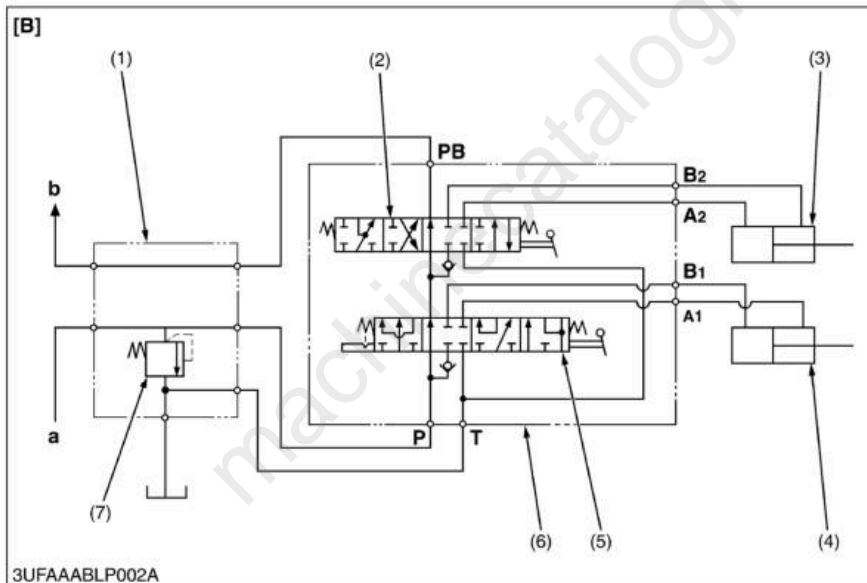

[5] CHECK AND MAINTENANCE

CAUTION

- When checking and repairing, park the tractor on flat ground and apply the parking brake.
- When checking and repairing, lower the bucket and stop the engine.

(1) Check Points of Each Use or Daily

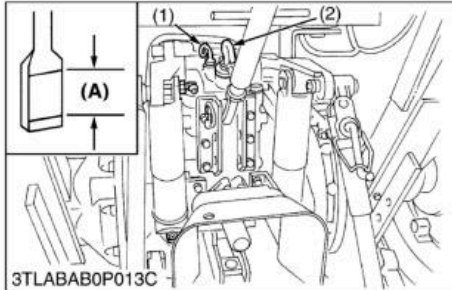

Checking Transmission Fluid Level

1. Check the oil level at the gauge (1).
2. If the level is too low, add new oil to the prescribed level at the oil.

- (1) Gauge
(2) Oil Filling Plug

(A) Oil level is acceptable within this range.

W1010960

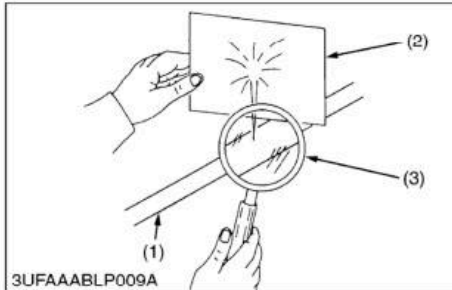

Checking Hydraulic Hoses

1. With the engine off and bucket on the ground, check all hydraulic hoses (1) for cuts or wear.
2. Check for signs of leaks and make sure all fittings are tight.
3. If defects are found, replace them.

- (1) Hydraulic Hose
(2) Cardboard

(3) Magnifying Glass

W1011064

(2) Check Points of Every 10 Hours

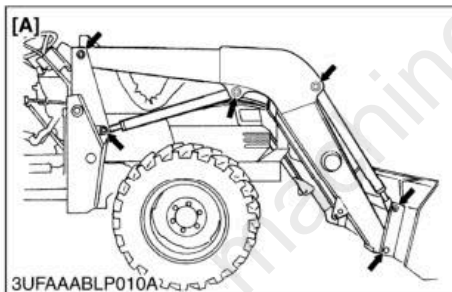

Greasing

1. Inject grease in all grease fitting with a hand grease gun.

[A] LA513

[B] LA723, LA853

W1011132

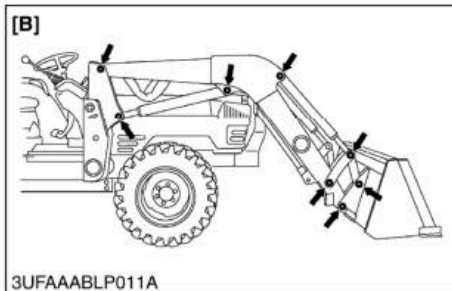

Lubricating

1. Lubricate joints of control lever linkage.

W1011274

[2] HYDRAULIC FITTINGS

(1) Distinguishing brass fitting and steel fitting

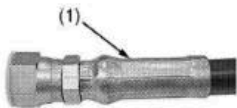
Material of caulking	Brass	Steel
Reference picture	 3UFAAABLP014A	 3UFAAABLP042A
Length of the caulking	Short	Long
Color of Caulking	Brass gold	Yellow zinc plating

(1) Crimp

NOTE

- The straight type fitting has both brass and steel.
- The elbow type fitting is only made of steel.

W1026862

(2) Hose fitting and flare nut

Thread Size	Tightening torque	
	Brass	Steel
9/16 - 18	16.3 to 17.6 N·m 1.7 to 1.8 kgf·m 12 to 13 ft-lbs	24.3 to 27.0 N·m 2.5 to 2.8 kgf·m 18 to 20 ft-lbs
3/4 - 16	31.2 to 33.9 N·m 3.2 to 3.5 kgf·m 23 to 25 ft-lbs	48.6 to 52.7 N·m 5.0 to 5.4 kgf·m 36 to 39 ft-lbs
7/8 - 14	50.2 to 55.6 N·m 5.1 to 5.7 kgf·m 37 to 41 ft-lbs	77.0 to 85.1 N·m 7.9 to 8.7 kgf·m 57 to 63 ft-lbs

W1026933

(3) Adjustable elbow and adaptor

Thread size	Tightening torque		
	N·m	kgf·m	ft-lbs
9/16	37 to 44	3.7 to 4.6	27 to 33
3/4	47 to 54	4.8 to 5.5	35 to 40

W1013389

(4) Adapter (NPT)

Thread size	Tightening torque		
	N·m	kgf·m	ft-lbs
3/8	39 to 44	3.9 to 4.4	28 to 32
1/2	49 to 58	5.0 to 5.9	36 to 43

NOTE

- When connecting a hose with flare nut, after tightening the nut with specified torque, return it approximately 45 degrees and re-tighten it to specified torque.

W1027438

[3] BUCKET, BOOM AND HYDRAULIC CYLINDERS

(1) Disassembling and Assembling

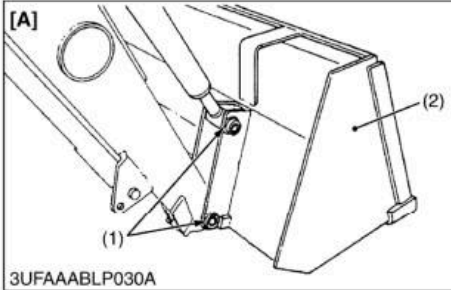

Bucket

1. Remove the pins (1) and remove the bucket (2).

- (1) Pin
- (2) Bucket

- [A] LA513
- [B] LA723, LA853

W1022133

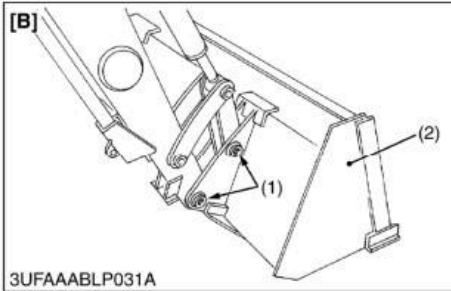

machinecatalogic.com

Full Version Available

Kubota LA723 Front Loader Workshop Manual

This is a short preview. The complete manual contains all chapters, wiring diagrams, torque specifications and full service procedures.

VIEW THE FULL MANUAL

<https://machinecatalogic.com/kubota-la723-front-loader-workshop-manual/>