

# WSM

---

WORKSHOP MANUAL  
TRACTOR

M100GX, M110GX, M126GX,  
M128GX, M128GX-FS,  
M135GX, M135GX-FS

---

**Кубота**

## (6) Oil Pump

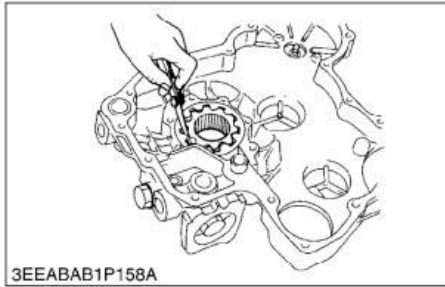

3EEABAB1P158A

### Clearance between Inner Rotor and Outer Rotor

1. Measure the clearance between the lobes of the inner rotor and the outer rotor with a feeler gauge.
2. If the clearance exceeds the allowable limit, replace the oil pump rotor assembly.

Clearance between Inner Rotor and Outer Rotor	Factory specification	0.040 to 0.16 mm 0.0016 to 0.0062 in.
	Allowable limit	0.3 mm 0.01 in.

9Y1210684ENS0126US0

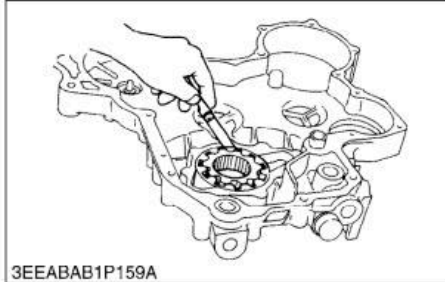

3EEABAB1P159A

### Clearance between Outer Rotor and Pump Body

1. Measure the clearance between the outer rotor and the pump body with a feeler gauge.
2. If the clearance exceeds the allowable limit, replace the oil pump rotor assembly.
3. If still the clearance exceeds the allowable limit after replacing the oil pump rotor assembly, replace the gear case.

Clearance between outer rotor and pump body	Factory specification	0.100 to 0.184 mm 0.00394 to 0.00724 in.
	Allowable limit	0.3 mm 0.01 in.

9Y1210684ENS0127US0

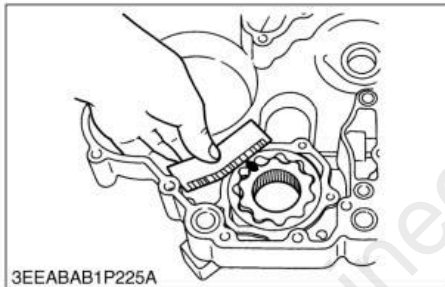

3EEABAB1P225A

### Clearance between Rotor and Cover

1. Put a strip of Plastigauge on the rotor face with grease.
2. Install the cover and tighten the screws with the specified torque.
3. Remove the cover carefully.
4. Measure the width that Plastigauge becomes flat with the scale to get the oil clearance.
5. If the clearance is more than the allowable limit, replace oil pump rotor assembly and the cover.

Clearance between rotor and cover	Factory specification	0.025 to 0.075 mm 0.00099 to 0.0029 in.
	Allowable limit	0.225 mm 0.00886 in.

Tightening torque	Oil pump cover screw	7.9 to 9.3 N-m 0.80 to 0.95 kgf-m 5.8 to 6.8 lbf-ft
-------------------	----------------------	---

9Y1210684ENS0128US0

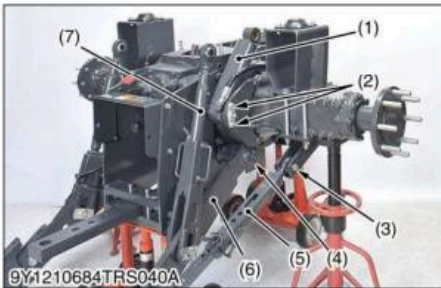

### **Lower Link and Hydraulic Cylinder**

1. Remove the screws (2) and pull out the cylinder pin and remove the hydraulic cylinder (1). (Both right and left side)
2. Remove the pin (3) and slotted nut (4), then remove the stabilizer (5), lower link (6) and lift rod (7) together. (Both right and left side)

#### **(When reassembling)**

- Install the split pin as shown in the figure.
- Tighten the slotted nut (4) by hand.
- Replace split pin with new one.

- |                        |                |
|------------------------|----------------|
| (1) Hydraulic Cylinder | (5) Stabilizer |
| (2) Screw              | (6) Lower Link |
| (3) Pin                | (7) Lift Rod   |
| (4) Slotted nut        |                |

9Y1210684TRS0046US0

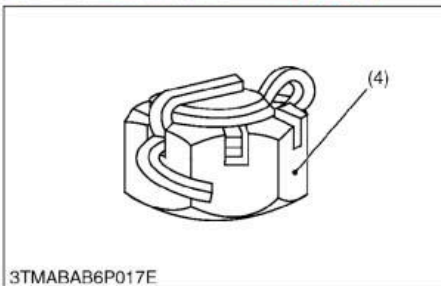

3TMABAB6P017E



### **PTO Clutch Valve Assembly**

1. Remove the PTO clutch valve mounting screws and remove the PTO clutch valve assembly.

#### **(When reassembling)**

- Replace the oil pipes (2) with new ones.
- Apply liquid gasket (Three Bond 1206D or equivalent) to joint face of mid case and transmission case, after eliminate the water, oil and stuck liquid gasket.

- |                               |              |
|-------------------------------|--------------|
| (1) PTO Clutch Valve Assembly | (2) Oil Pipe |
|-------------------------------|--------------|

9Y1210684TRS0047US0

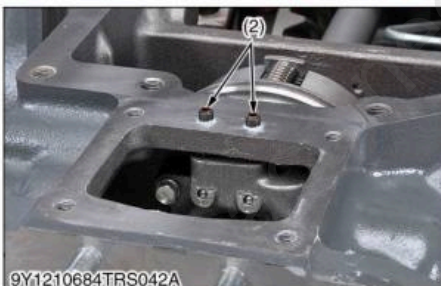

9Y1210684TRS042A

Symptom	Probable Cause	Solution	Reference Page
Chassis Does not Descend	Solenoid for lock cancellation broken	Replace	5-S50

9Y1210684FAS0002US0

machinecatalogic.com

**[E] Mode "CHK-5" (Checking the DTC (Diagnostic Trouble Code) History for the Suspension System)**

**Step 1: Selecting Menu and Mode**

1. Select the menu "CHK". (See page 8-S19.)
2. Select the mode "CHK-5" (Checking the DTC history for the suspension system). (See page 8-S20.)

■ **NOTE**

- It is unnecessary to start the engine when carrying out the mode "CHK-5".

9Y1210684ELS0090US0

**Step 2: Checking the DTC (Diagnostic Trouble Code) History**

1. The displayed DTC changes in order from the latest DTC to the oldest DTC every time pushing the display switch.

■ **NOTE**

- Refer to the page 8-S16 for the detail of DTC.
- If there is no DTC history, "NOERR" appears in the display.
- The number of DTC history is up to 32.
- If the number of DTC history is more than 32, the oldest DTC data is deleted and the latest DTC data is added automatically.

2. After the oldest DTC, "END" is displayed in the LCD.
3. Turn the main key switch off to finish the mode "CHK-5".

- (1) Display Switch
- (2) DTC (Diagnostic Trouble Code)
- (3) DTC History Number ("1" is the Latest DTC)

- (A) Displaying DTC
- (B) There is no DTC History
- (C) Displaying DTC
- (D) Display Next to the Oldest DTC

9Y1210684ELS0091US0

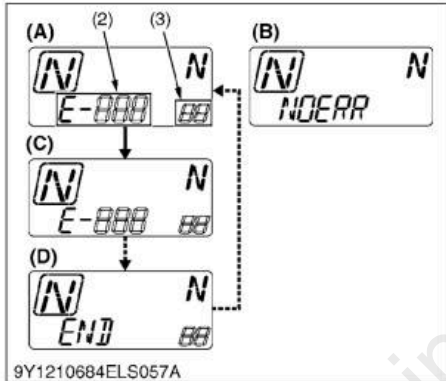
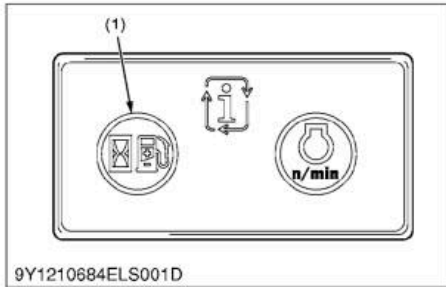

# Full Version Available

Kubota M135GX Tractor Workshop Manual

This is a short preview. The complete manual contains all chapters, wiring diagrams, torque specifications and full service procedures.

**VIEW THE FULL MANUAL**

<https://machinecatalogic.com/kubota-m135gx-tractor-workshop-manual/>