

TO THE READER

This Workshop Manual has been prepared to provide servicing personnel with information on the mechanism, service and maintenance of Kubota Tractor M4950(DT), M5950(DT), M6950(DT) and M7950(DT). It is divided into two parts, "Mechanism" and "Disassembly and Servicing."

■ Mechanism

Information on construction and function are included for each tractor section. This part should be understood before proceeding with troubleshooting, disassembly and servicing.

■ Disassembly and Servicing

Under the heading "General" comes general precautions, troubleshooting, and lists of servicing reference values and periodic inspection items. For each tractor section, there are "Checking and Adjustment", "Disassembly and Assembly", and "Servicing" which cover procedures, precautions, reference values and allowable limits.

For a detailed engine description for S2800 [M4950(DT)], refer to "Kubota Diesel Engine Work Shop Manual S2200-B · S2600-B · S2800-B" (Code No: 07909-70108), and for D3200 [M5950(DT)], V4000-2 [M6950(DT)] and V4300 [M7950(DT)], refer to "Kubota Diesel Engine Workshop Manual D3000-B · D3200-B · V4000-B · V4300-B" (Code No: 07909-70103).

All information, illustrations and specifications contained in this manual are based on the latest production information available at the time of publication. The right is reserved to make changes in all information at any time without notice.

Jan. '84

© KUBOTA Corporation 1992

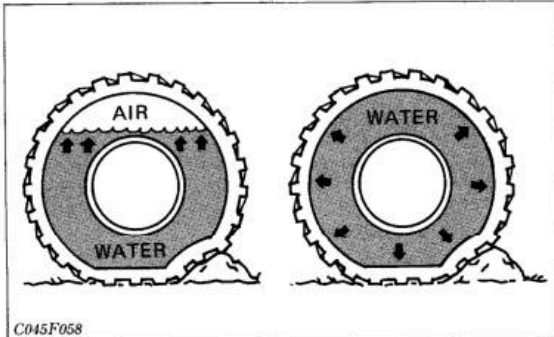

C045F058

- (1) Correct—75% Air compresses like a cushion
- (2) Incorrect—100% Full Water can't be compressed

CAUTION:

- Do not fill tires with water or solution more than 75% of full capacity (to the valve stem level).

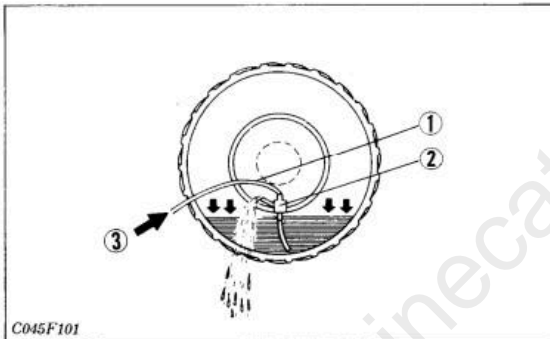

C045F101

- (1) Hose
- (2) Injector
- (3) Compressed Air

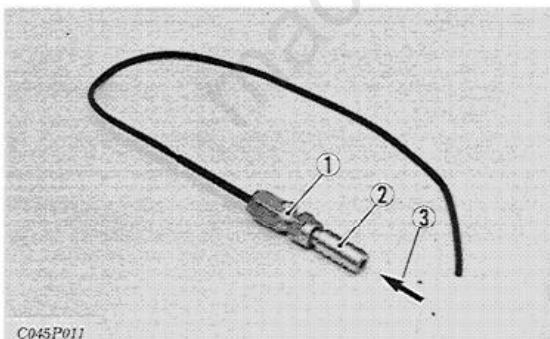

C045P011

- (1) Vent
- (2) Injector
- (3) Compressed Air

Weight of Calcium Chloride Solution Filling 75% of Full Capacity of a Tire.

Slush free at -10°C (13°F) Solid at -30°C (-23°F) [Approx. 1kg (2 lbs.) CaCl_2 per 4ℓ (1 U.S. gal.) of water]	16.9/14–30	314Kg(693 lbs)
	16.9/14–34	352Kg(775 lbs)
	13.6/12–38	244Kg(538 lbs)
Slush free at -24°C (-12°F) Solid at -47°C (-52°F) [Approx. 1.5kg (3.5 lbs.) CaCl_2 per 4ℓ (1 U.S. gal.) of water]	16.9/14–30	338Kg(746 lbs)
	16.9/14–34	376Kg(829 lbs)
	13.6/12–38	264Kg(581 lbs)
Slush free at -47°C (-52°F) Solid at -52°C (-62°F) [Approx. 2.25kg (5 lbs.) CaCl_2 per 4ℓ (1 U.S. gal.) of water]	16.9/14–30	357Kg(787 lbs)
	16.9/14–34	399Kg(880 lbs)
	13.6/12–38	279Kg(614 lbs)

IMPORTANT:

- With the front loader work, do not fill front tires with liquid.

Draining water or solution

1. Lift the rear tires off the ground.
2. Turn the tire so that the air valve is at the bottom.
3. Remove the air valve, and drain liquid (liquid can only be drained to the level of the valve and liquid under that level remains inside).
4. To drain liquid completely, use the injector, and direct compressed air into the tire to force out the liquid through the injector's vent.

[9] SPECIAL TOOLS

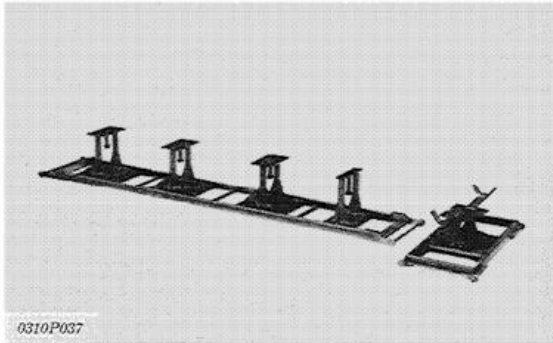

0310P037

Disassembly Stands

Code No: 07916-53021

Application: This stands can be used to safety hold the front axle, engine, clutch housing and transmission case.
(See page S.S-3)

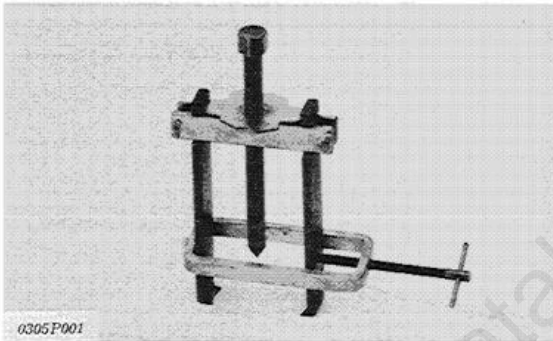

0305P001

Special-use Puller Set

Code No: 07916-09032

Application: Use exclusively for pulling out bearings, gears and other parts with ease.
(See page S.2-3, S.3-2, 5, S.5-15)

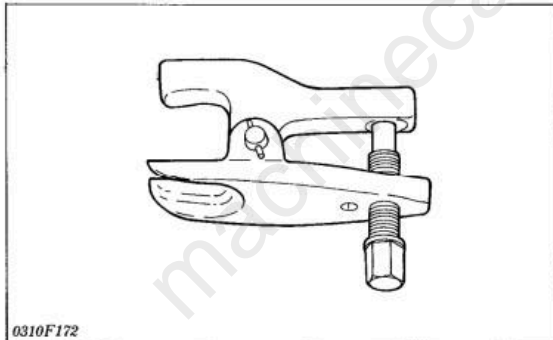

0310F172

Tie-rod End Lifter

Code No: 07909-39051

Application: This allows easy removal of the tie-rod ends.
(See page S.S-7, 8 · S.5-4, 7)

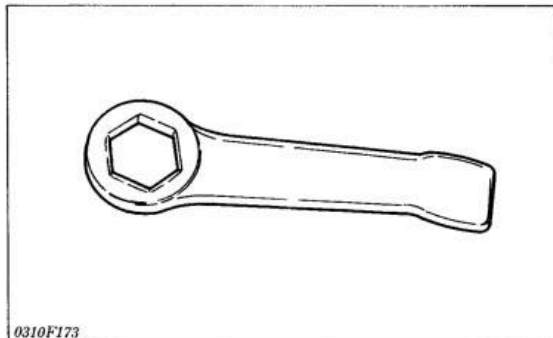

0310F173

Socket Wrench 50

Code No: 07916-31840

Application: Use for removing the staking nut from the front bevel pinion shaft and reassembling it.
(See page S.5-12)

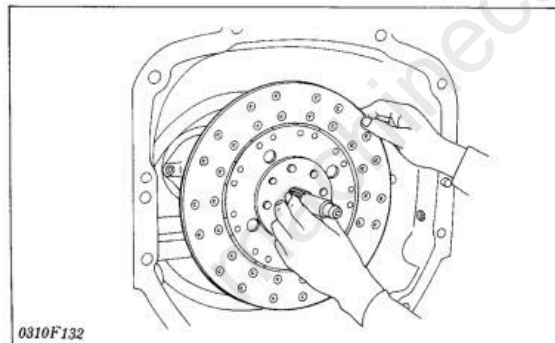
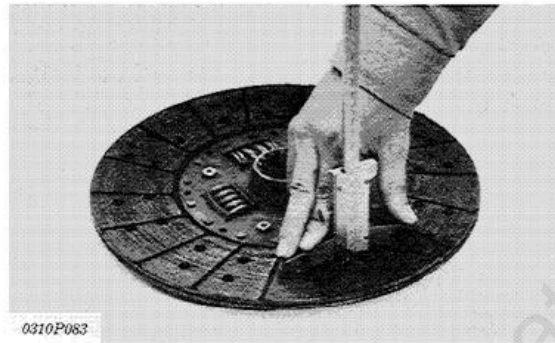
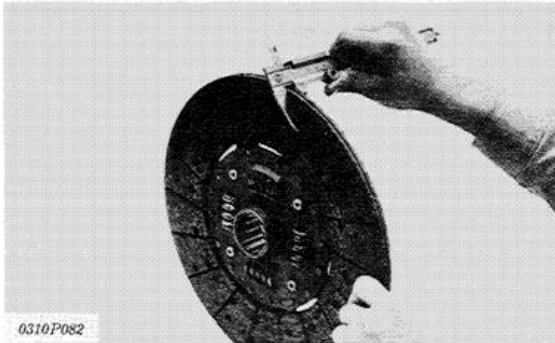

SERVICING

Clutch Disc Thickness

1. Measure the thickness of the travelling clutch disc facing.
2. Measure the depth from the surface of the travelling clutch disc facing to the rivet.
3. If the measurement is less than the allowable limit, replace it.
4. If oil or grease is adhering to the clutch disc facing, replace it.

Clutch disc thickness (travelling)	Reference value	9.1 to 9.7mm 0.358 to 0.382 in.
	Allowable limit	6.9mm 0.272 in.
Depth to rivet top	Allowable limit	0.5mm 0.020 in.

5. Perform measurement for the PTO clutch disc in the same way as above.

Clutch disc thickness (PTO)	Reference value	8.1 to 8.7mm 0.319 to 0.343 in.
	Allowable limit	5.9mm 0.232 in.
Depth to rivet top	Allowable limit	0.5mm 0.020 in.

Spline Backlash between Clutch Disc Boss and Shaft

1. Mount the travelling clutch disc to the 1st shaft.
2. Hold the 1st shaft so that it does not turn.
3. Rotate disc lightly and measure the displacement around the disc edge.
4. If the measurement exceeds the allowable limit, replace it.

Displacement around disc edge (travelling)	Allowable limit	2.0mm 0.079 in.
--	-----------------	--------------------

5. Perform measurement for the PTO clutch disc and PTO propeller shaft in the same way as above.

Displacement around disc edge (PTO)	Allowable limit	3.5mm 0.138 in.
-------------------------------------	-----------------	--------------------

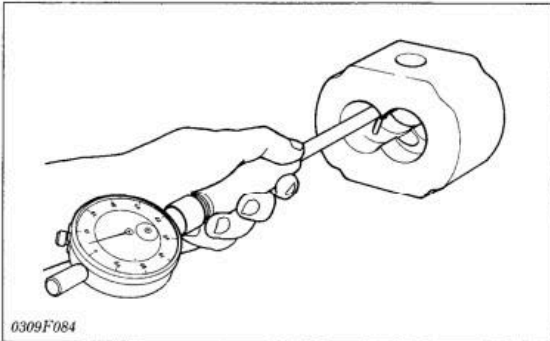

SERVICING

Housing Bore

1. Measure the housing I.D. where the interior surface is not scratched, and measure the housing I.D. where the interior surface is scratched. Use a cylinder gauge to measure the housing I.D.
2. If the values obtained in the two determinations differ by more than the allowable limit, replace the hydraulic pump as a unit.

Depth of scratch	Allowable limit	0.09 mm 0.0035 in.
------------------	-----------------	-----------------------

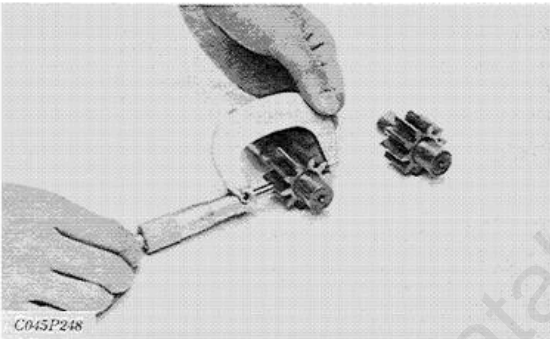

Gear O.D.

1. Measure the gear O.D. with an outside micrometer.
2. If the measurement is less than the allowable limit, replace it.

Gear O.D.	Allowable limit	37.34mm 1.4701 in.
-----------	-----------------	-----------------------



Clearance between Bushing and Gear Shaft

1. Measure the gear shaft O.D. with an outside micrometer.
2. If the gear shaft O.D. is less than the allowable limit, replace as a unit.
3. Measure the bushing I.D. with an inside micrometer.
4. If the clearance exceeds the allowable limit, replace as a unit.

Gear shaft O. D.	Allowable limit	17.968 mm 0.70740 in.
Clearance between bushing and shaft	Allowable limit	0.15 mm 0.0059 in.

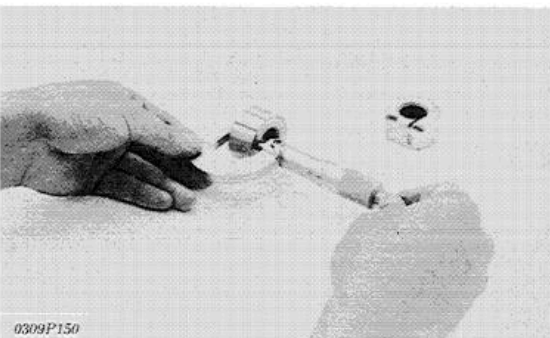

Bushing Length

1. Measure the bushing length with an outside micrometer.
2. If the length is less than the allowable limit, replace it.

Bushing length	Allowable limit	18.965mm 0.74665 in.
----------------	-----------------	-------------------------

Full Version Available

Kubota M5950(DT) Tractor Workshop Manual

This is a short preview. The complete manual contains all chapters, wiring diagrams, torque specifications and full service procedures.

VIEW THE FULL MANUAL

<https://machinecatalogic.com/kubota-m5950-dt-tractor-workshop-manual/>